



www.keymat.com

USA OFFICE
Suite 202
364, Pennsylvania Avenue,
Glen Ellyn
Illinois 60137
USA

e.mail: sales@keymat.com

UK OFFICE
14, Bentinck Court
Bentinck Road,
West Drayton
UB7 7RQ
ENGLAND

This document is provided for use and guidance of engineering personnel engaged in the installation or application of STORM data entry products manufactured by Keymat Technology Ltd. Please be advised that all information, data, and illustrations contained within this document remain the exclusive property of Keymat Technology Ltd. and are provided for the express and exclusive use as described above. This document is not supported by Keymat Technology's engineering change note, revision or reissue system. Data contained within this document is subject to periodic revision, reissue or withdrawal. Whilst every effort is made to ensure the information, data and illustrations are correct at the time of publication, Keymat Technology Ltd. are not responsible for any errors or omissions contained within this document.



1200 Sub-miniature keyboard for public environments Application / Engineering Manual

Table of Contents.

	<u>Page.</u>
Section 1. Overview.	3
Section 2. Options (colours, materials, configurations).	4
Section 3. Installation in host equipment.	5
Section 4. Connectors and connections.	6,7,8
Section 5. Ratings and Performance.	9
Section 6. Availability/Reliability/Maintainability.	10
Serviceability.	
Warranty.	
Section 7. Ordering Details - Keyboards.	11
Appendix 1. Keyboard Layouts :	
UK	12
US	13
Appendix 2. Panel Mounting Details / Overall Dimensions.	14,15
Appendix 3. Keyboard Scan Codes.	16,17,18

This document is provided for use and guidance of engineering personnel engaged in the installation or application of STORM data entry products manufactured by Keymat Technology Ltd. Please be advised that all information, data, and illustrations contained within this document remain the exclusive property of Keymat Technology Ltd. and are provided for the express and exclusive use as described above. This document is not supported by Keymat Technology's engineering change note, revision or reissue system. Data contained within this document is subject to periodic revision, reissue or withdrawal. Whilst every effort is made to ensure the information, data and illustrations are correct at the time of publication, Keymat Technology Ltd. are not responsible for any errors or omissions contained within this document.

Section 1. Overview.

Developed for use in a new generation of web enabled public telephones and transaction terminals, this small but highly responsive keyboard is suitable for use in exposed or hostile environments. It's robust construction is highly resistant to hard use, abuse and vandalism. It is sealed against water and dust to ensure responsive and reliable data entry in the most demanding situations. The keyboard's front panel and keytop characters can be customised to complement the colour scheme, design and function of almost any host equipment. Encoding electronics are an option that can be specified and integrated into the keyboard construction providing a plug compatible, ready to use, solution for almost any PC based application.

Weather and vandal resistant for outdoor and unsupervised public environments.

Integrated PC / USB compatible interface (optional).

Rapid, responsive and reliable data entry.

Stainless steel front plate.

Easily and securely installed in public web-phones, vending machines, automated teller machines, transaction terminals, public internet kiosks etc.





1200 Sub-miniature keyboard for public environments Application / Engineering Manual

Section 2. Options.

The STORM 1200 is a versatile data entry keyboard that can be configured to suit many applications. A number of cosmetic and functional options can be selected to achieve the optimum environmental or operational performance. The options marked with a ● should be considered as “**required to achieve vandal resistant specification**”.

The following table shows the range and availability of optional features. Check the boxes to indicate your selected options.

Option ● = Required (not optional) <input type="checkbox"/> = Optional ✓if required - = Not available	Vandal Resistant Spec
Resistance to water and dust.	IP65 Low pressure water jet
Switch Contact Resistance	100 ohms (max)
Brushed Stainless Steel Front Plate	●
Silver Chromed metal keys.	●
Moulded polymer keys with laser engraved keytop graphics.	<input type="checkbox"/>
Panel mounting kit to secure the keyboard against the under surface of a fascia panel or equipment casing. (See section 3 Installing and fixing the keyboard).	<input type="checkbox"/>
Factory fitted Molex Picoflex connector, Part Number 90814-3320, attached to the keyboard's rear surface.	<input type="checkbox"/>
Recommended mating connector for ribbon cable.	Molex Picoflex Part Number 90327-3320
Factory fitted PS2 / USB compatible encoder, enabling direct connection to a PC's keyboard or USB port. (Cable required).	<input type="checkbox"/>
Keyboard cable, 2.5m length, fitted with a male USB connector at the PC end	<input type="checkbox"/>
Keyboard cable, 2.5m length, fitted with a male 5 pin DIN connector at the PC end	<input type="checkbox"/>

This document is provided for use and guidance of engineering personnel engaged in the installation or application of STORM data entry products manufactured by Keymat Technology Ltd. Please be advised that all information, data, and illustrations contained within this document remain the exclusive property of Keymat Technology Ltd. and are provided for the express and exclusive use as described above. This document is not supported by Keymat Technology's engineering change note, revision or reissue system. Data contained within this document is subject to periodic revision, reissue or withdrawal. Whilst every effort is made to ensure the information, data and illustrations are correct at the time of publication, Keymat Technology Ltd. are not responsible for any errors or omissions contained within this document.



1200 Sub-miniature keyboard for public environments Application / Engineering Manual

Section 3. Installation in host equipment.

The STORM 1200 keyboard must be securely fitted into a fascia panel or equipment casing.

For effective resistance to vandalism, abuse and rough use the STORM 1200 should be installed from the underside of a panel, with the operational face of the keyboard accessible through a rectangular aperture in the panel, Appendix 2 refers.

The STORM 1200 is secured into place by a retaining plate (in Mounting Kit Pt. No. 1200-MK000x) located on 8 M3 x 16 mm studs. (See Appendix 2).

Recommended dimensions and profile for the panel aperture and positions of the fixing studs are detailed as "non-revision supported copy". The keyboard's integral sealing rib (positioned on the top face of the peripheral flange) is compressed between the flange's top face and the rear surface of the fascia panel. The rear surface of the fascia panel must be rigid, flat, and free of debris to achieve rated resistance to water and dust. The keyboard's integral seal should be checked to ensure it is free from damage and debris prior to installation or refit.

The overall dimensions are as shown below:

1200 Keyboard.	
Overall Length mm (ins)	175,0 (6.8 in)
Overall Width mm (ins)	85,0 (3.3 in)
Overall Depth underpanel mm (ins)	21,5 (0.85 in)
Weight Kg	0.549

This document is provided for use and guidance of engineering personnel engaged in the installation or application of STORM data entry products manufactured by Keymat Technology Ltd. Please be advised that all information, data, and illustrations contained within this document remain the exclusive property of Keymat Technology Ltd. and are provided for the express and exclusive use as described above. This document is not supported by Keymat Technology's engineering change note, revision or reissue system. Data contained within this document is subject to periodic revision, reissue or withdrawal. Whilst every effort is made to ensure the information, data and illustrations are correct at the time of publication, Keymat Technology Ltd. are not responsible for any errors or omissions contained within this document.

Section 4. Connectors and connections.

The 1200 Keyboard is supplied either as a **matrix keypad** with row column output via a 20 way Molex Connector, or **with an integral encoder** with PS2 or PS2/USB switchable output depending on the options chosen.

The 1200 Keyboard has a standard PS2 output or a selectable PS2/USB output that is configured by the user via a switch on the Encoder pcb at the time that the cable is connected to the Keyboard.

Cables are not supplied with the 1200 Keyboard in order that the user can select the correct cable length and connector type to suit their application. (see Section 7 for available cables)

Cables are offered as separately purchased options, Section 7 refers.

Matrix Keypad Version with Row/Column Output

The keyboard's 53 keys are momentary contact (carbon to gold on nickel on copper contact) switches, positioned on a 6 row x 14 column circuit matrix as defined in Table 1. This circuit matrix is terminated via a 20 way Molex Picoflex connector (part number 90814-3220). See figure 1.

To connect a 20 line ribbon cable to this connector, it is recommended to use the mating Molex Picoflex connector (part number 90327-3320). Current specifications and ratings for these components (or other compatible molex connectors) should be sought from the manufacturer at www.molex.com

Figure 1. Picoflex Connector

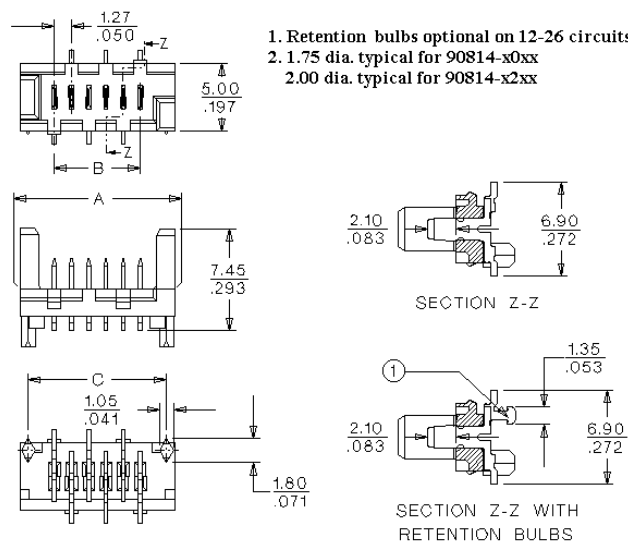

	Dimensions in mm (inches)		
Number of connections	A (Overall Length)	B (1st to Last Ckt)	C
20	29.18(1.149)	24.13(.950)	27.98(1.102)

Table 1 below, shows the connector pin designation for the switch circuit matrix.

Please Note: When the keyboard is viewed from the rear, with the connector positioned towards the bottom edge of the keyboard, pin 1 is on the right, pin 20 is on the left.

Table 1.

Connector pin designator.	
Connector Pin Number	Row / Column
1	Column 14
2	Column 13
3	Column 12
4	Column 11
5	Column 10
6	Column 9
7	Column 8
8	Column 7
9	Column 6
10	Column 5
11	Column 4
12	Column 3
13	Column 2
14	Column 1
15	Row F
16	Row E
17	Row D
18	Row C
19	Row B
20	Row A

Keypop Layouts are detailed in Appendix 1.

Appendix 3 shows the row and column connection for each switch position. Please note; the characters indicating row and column connections are not representative of keytop layouts.

Encoded Version with PS2 or USB Output

The encoder daughterboard has a 5 way Molex male connector which mates with the corresponding female housing supplied fitted to the accessory cable. The pinout details for these are shown below.

The scan codes for each key position are listed in Appendix 3.

Diagrams showing pin designations.

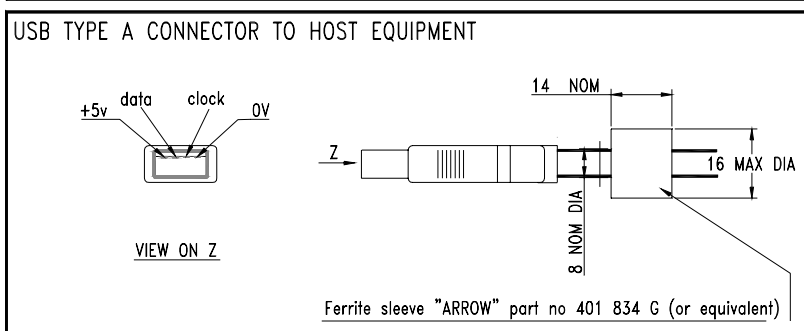
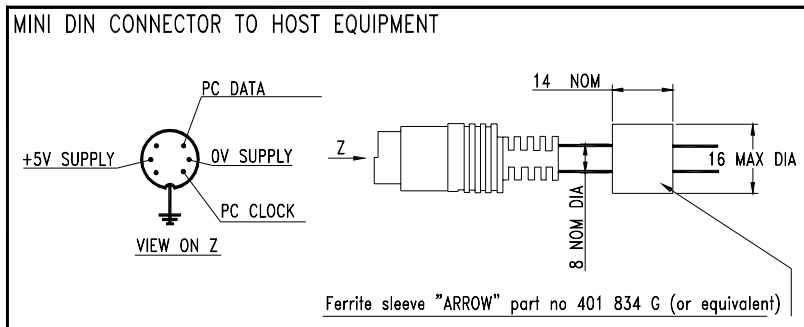
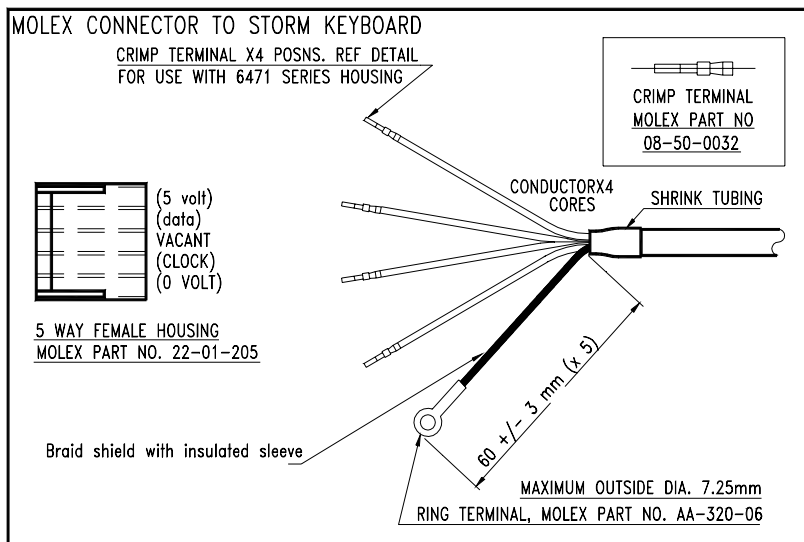

This document is provided for use and guidance of engineering personnel engaged in the installation or application of STORM data entry products manufactured by Keymat Technology Ltd. Please be advised that all information, data, and illustrations contained within this document remain the exclusive property of Keymat Technology Ltd. and are provided for the express and exclusive use as described above. This document is not supported by Keymat Technology's engineering change note, revision or reissue system. Data contained within this document is subject to periodic revision, reissue or withdrawal. Whilst every effort is made to ensure the information, data and illustrations are correct at the time of publication, Keymat Technology Ltd. are not responsible for any errors or omissions contained within this document.

Section 5. Ratings and performance.

The following table shows the designed operational and performance data. Achieved performance may depend on environmental or operational conditions and mode of use.

Key to symbols ● = Required for Vandal Resistance - = Not applicable	Vandal Resistant Spec
Resistance to water and dust.	IP65 Low pressure water jet ●
Operational Temperature	-20°C to +60°C
Impact Resistance	20 Joules via 50mm dia steel striker to EN60068-2-75 : 1997
Switch Contact Resistance	100 ohms (max)
Switch Contact Bounce	5ms (max)
Insulation Resistance	50 Mohms (min)
Breakdown Voltage	500V AC (max 60 secs)
Operating Voltage	24V DC (max)
Operating Current	50mA (max)
Operational Life	4 million cycles per key (min)
Keytop travel	1.25mm nominal
Key actuation force	120gms nominal
<u>Matrix Keypad Version Options</u>	
Connector (Factory fitted to the rear face of the keyboard).	Molex Picoflex Part Number 90814-3220
Recommended mating connector for ribbon cable.	Molex Picoflex Part Number 90327-3320

<u>Flammability of Major Plastic Parts (taken from Material Suppliers Datasheets)</u>	<u>UL94 Rating</u>
Case Moulding	V-0
Rubber Actuators	HB
Insulator	V-0
Circuit Boards	V-0

Section 6. Availability/Reliability/Maintainability.

Firmware.

The firmware version is shown on the back of the microchip controller .

Serviceability .

*The STORM 1200 keyboard is designed for use in exposed, unsupervised public environments. It is rugged, reliable and weather resistant to provide years of trouble free and responsive data entry. The keyboard is assembled and sealed under strictly controlled factory conditions, using calibrated and highly specialized tooling. It should not be disassembled or modified by anyone other than trained technicians (under controlled conditions) in our UK manufacturing facility. **There are no user serviceable parts contained within the 1200 keyboard. Disassembly or modifications carried out by non-authorized personnel will invalidate any warranties and have a detrimental effect on the products performance and reliability.***

The keyboard should be regularly cleaned by washing the operational surface with weak solution of detergent and water. Care should be taken to ensure that no liquids enter the rear face of the keyboard or the connector mechanism.

Warranty.

Policy Statement.

It is Keymat Technology's intention to provide a fair and rapid response when any customer reports a defect in any product supplied by Keymat Technology.

If a valid warranty claim is received, then it is our policy to repair, replace or provide a credit note for those defective products as quickly as possible and with minimum inconvenience to our customers.

Exclusions.

Product shipped more than 12 months before the date of claim are not covered by warranty.

Product damaged in use is not covered by warranty.

Product that has been modified is not covered by warranty.

Product where the serial number / batch numbers have been removed or modified are not covered by warranty.

Product that has been stripped down for any reason by the customer is not covered by warranty.

Appendix 1. Key Layout.

UK Layout.

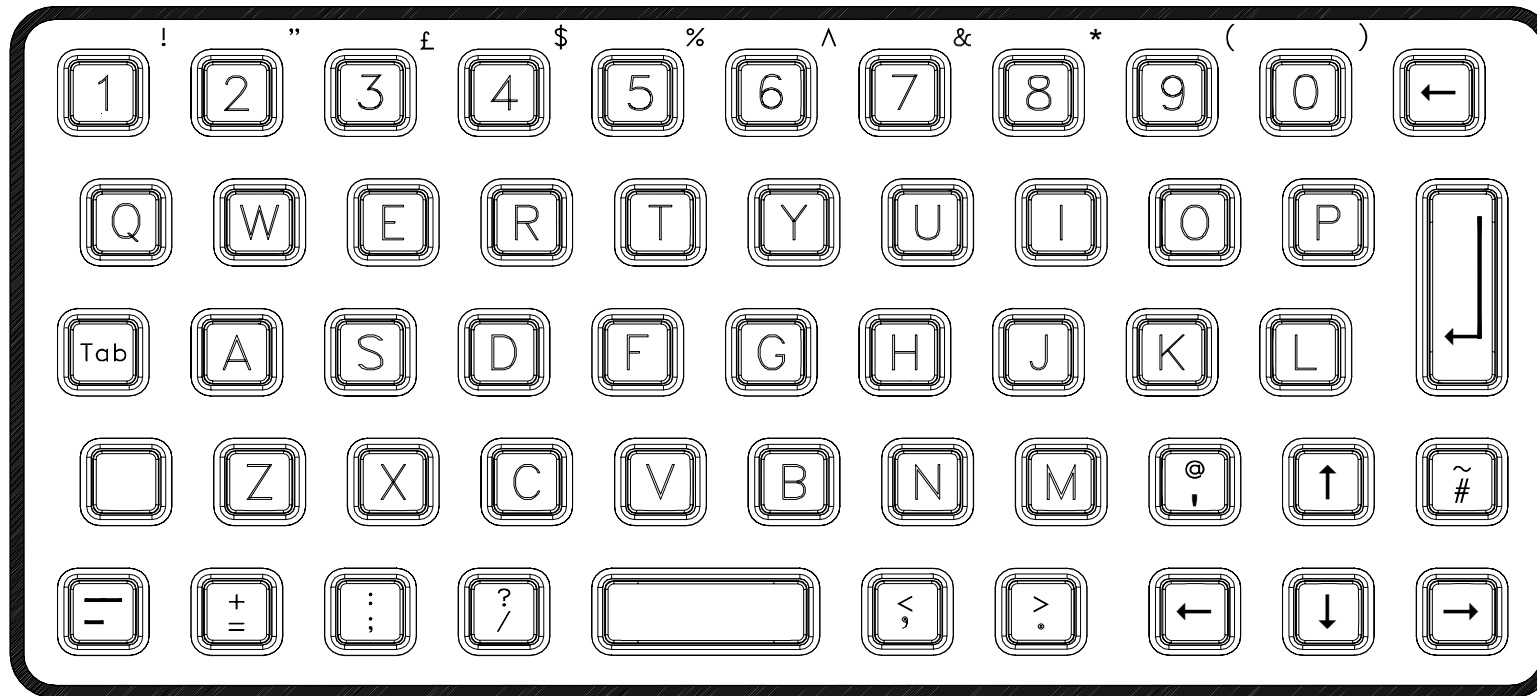

US Layout

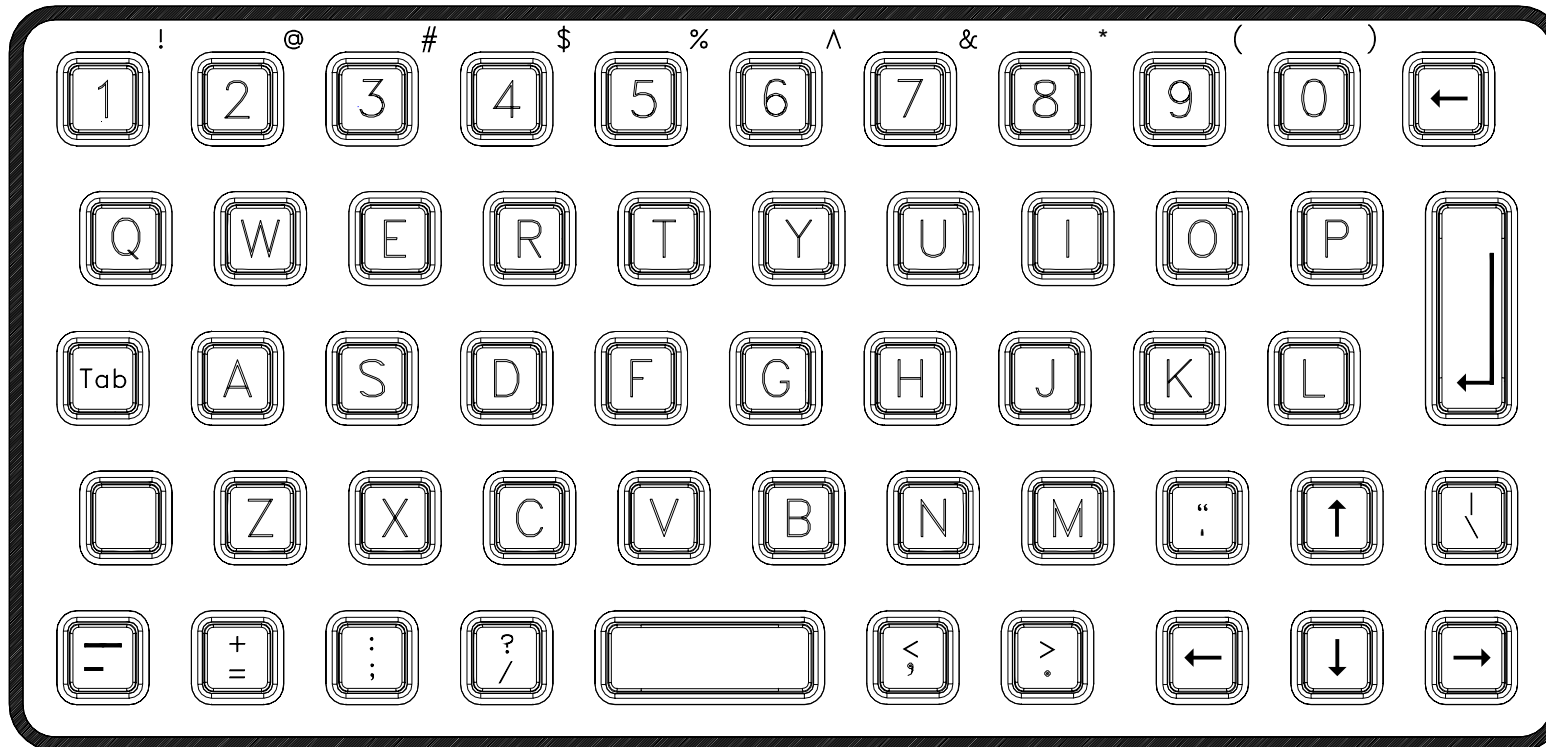

Appendix 2: Panel Mounting Details / Overall Dimensions.

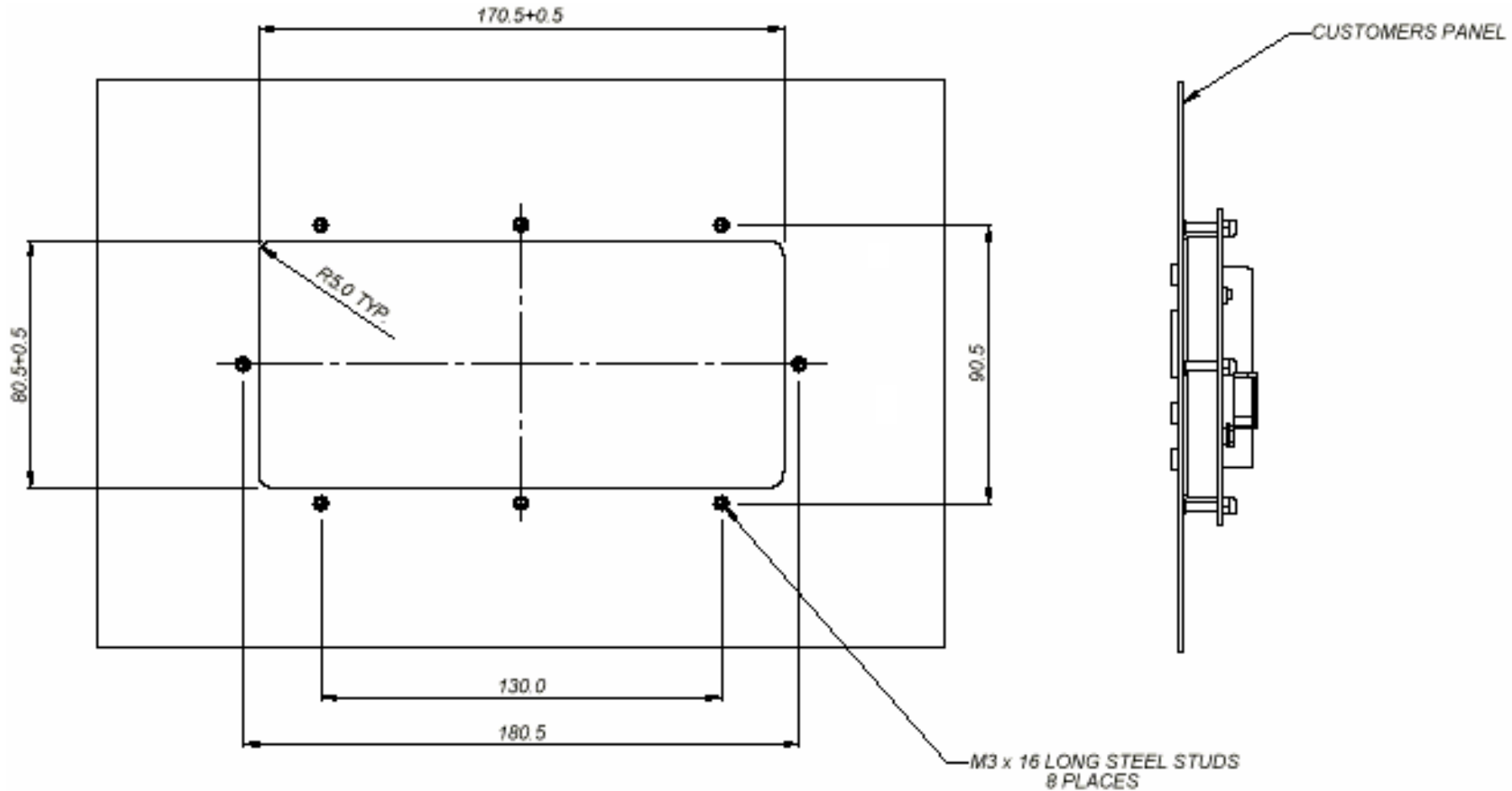

This document is provided for use and guidance of engineering personnel engaged in the installation or application of STORM data entry products manufactured by Keymat Technology Ltd. Please be advised that all information, data, and illustrations contained within this document remain the exclusive property of Keymat Technology Ltd. and are provided for the express and exclusive use as described above. This document is not supported by Keymat Technology's engineering change note, revision or reissue system. Data contained within this document is subject to periodic revision, reissue or withdrawal. Whilst every effort is made to ensure the information, data and illustrations are correct at the time of publication, Keymat Technology Ltd. are not responsible for any errors or omissions contained within this document.

Keyboard Overall Dimensions.

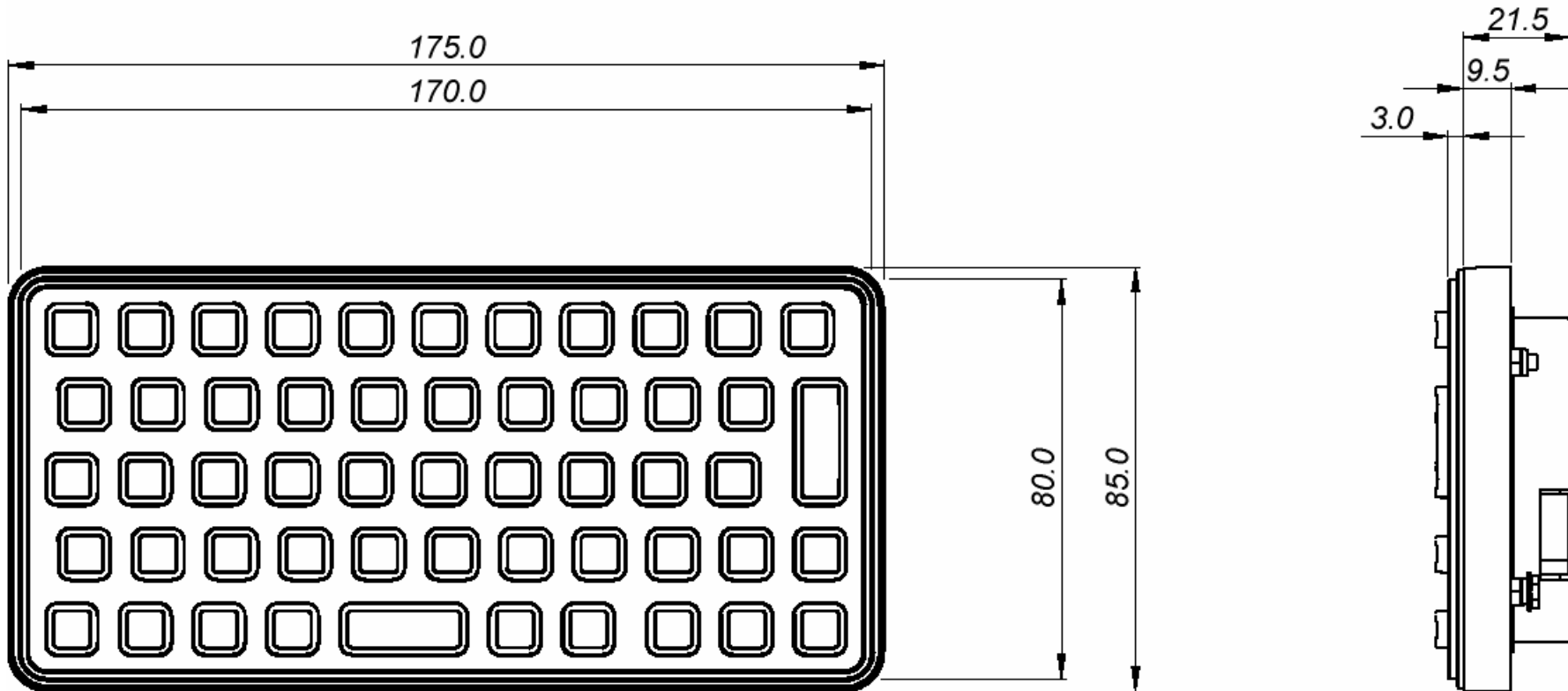

Appendix 3: Keyboard Scan Codes.

Drawing reference for Key positions.

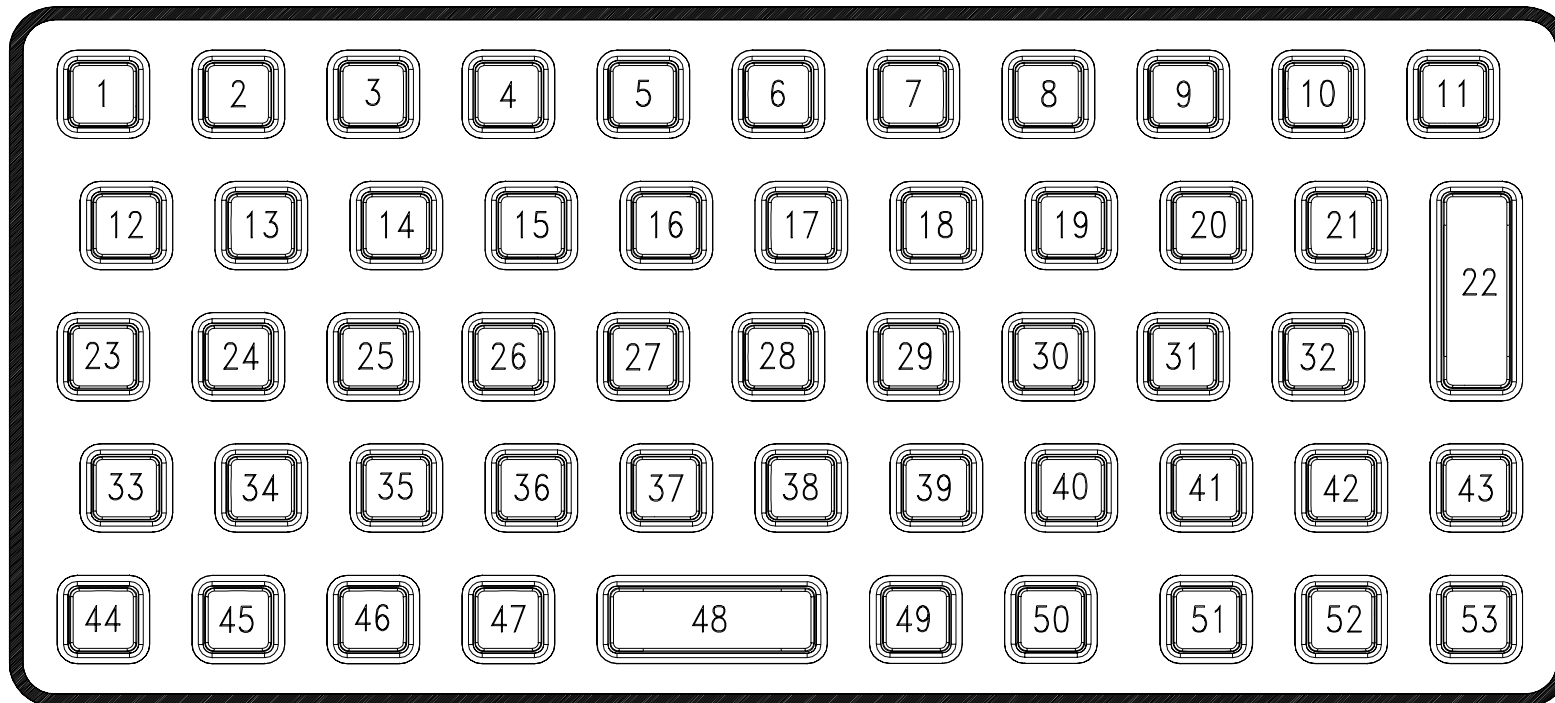



1200 Sub-miniature keyboard for public environments Application / Engineering Manual

Scan Codes.

Key Position	Column	Row	Key Assignment UK Layout		Key Assignment US Layout						PC/AT Code (Code Set 2)
			Base	Shifted	Base	Shifted					
1	2	1	1	!	1	!					16
2	3	1	2	"	2	@					1E
3	4	1	3	£	3	#					26
4	5	1	4	\$	4	\$					25
5	6	1	5	%	5	%					2E
6	7	1	6	^	6	^					36
7	8	1	7	&	7	&					3D
8	9	1	8	*	8	*					3E
9	10	1	9	(9	(46
10	11	1	0)	0)					45
11	13	3	B/Space		B/Space						66
12	2	2	q	Q	q	Q					15
13	3	2	w	W	w	W					1D
14	4	2	e	E	e	E					24
15	5	2	r	R	r	R					2D
16	6	2	t	T	t	T					2C
17	7	2	y	Y	y	Y					35
18	8	2	u	U	u	U					3C
19	9	2	i	I	i	I					43
20	10	2	o	O	o	O					44
21	11	2	p	P	p	P					4D
22	13	4	Enter		Enter						5A
23	1	2	TAB		TAB						0D
24	2	3	a	A	a	A					1C
25	3	3	s	S	s	S					1B
26	4	3	d	D	d	D					23
27	5	3	f	F	f	F					2B
28	6	3	g	G	g	G					34
29	7	3	h	H	h	H					33

This document is provided for use and guidance of engineering personnel engaged in the installation or application of STORM data entry products manufactured by Keymat Technology Ltd. Please be advised that all information, data, and illustrations contained within this document remain the exclusive property of Keymat Technology Ltd. and are provided for the express and exclusive use as described above. This document is not supported by Keymat Technology's engineering change note, revision or reissue system. Data contained within this document is subject to periodic revision, reissue or withdrawal. Whilst every effort is made to ensure the information, data and illustrations are correct at the time of publication, Keymat Technology Ltd. are not responsible for any errors or omissions contained within this document.



1200 Sub-miniature keyboard for public environments Application / Engineering Manual

Key Position	Column	Row	Key Assignment UK Layout		Key Assignment US Layout						PC/AT Code (Code Set 2)	
30	8	3	j	J	j	J						3B
31	9	3	k	K	k	K						42
32	10	3	l	L	l	L						4B
33	14	4	Shift		Shift							12
34	3	4	z	Z	z	Z						1A
35	4	4	x	X	x	X						22
36	5	4	c	C	c	C						21
37	6	4	v	V	v	V						2A
38	7	4	b	B	b	B						32
39	8	4	n	N	n	N						31
40	9	4	m	M	m	M						3A
41	12	3	'	@	'	"						52
42	11	6	↑		↑							E0,75
43	12	2	#	~	\							5D
44	12	1	-	_	-	_						4E
45	13	1	=	+	=	+						55
46	11	3	;	:	;	:						52
47	12	4	/	?	/	?						4A
48	7	5	Space		Space							29
49	10	4	,	<	,	<						41
50	11	4	.	>	.	>						49
51	10	6	←		←							E0,6B
52	12	6	↓		↓							E0,72
53	13	6	→		→							E0,74

Release Codes.

The PC/AT release code for each key is the Scan Code preceded by H'F0'.

Example:

Q – H'F0', H'15.

Exception : Keys with Scan Codes starting with H'E0, the release code sequence (for example Left Arrow) is, H'E0', H'F0'. H'6B'

This document is provided for use and guidance of engineering personnel engaged in the installation or application of STORM data entry products manufactured by Keymat Technology Ltd. Please be advised that all information, data, and illustrations contained within this document remain the exclusive property of Keymat Technology Ltd. and are provided for the express and exclusive use as described above. This document is not supported by Keymat Technology's engineering change note, revision or reissue system. Data contained within this document is subject to periodic revision, reissue or withdrawal. Whilst every effort is made to ensure the information, data and illustrations are correct at the time of publication, Keymat Technology Ltd. are not responsible for any errors or omissions contained within this document.